

LIVING-LIGHT



CATALOGUE
2018-2019

LIVING-LIGHT

In one single range

Three key finishes: white, tech, anthracite

More than 50 plate finishes in 3 designs

All fully interchangeable

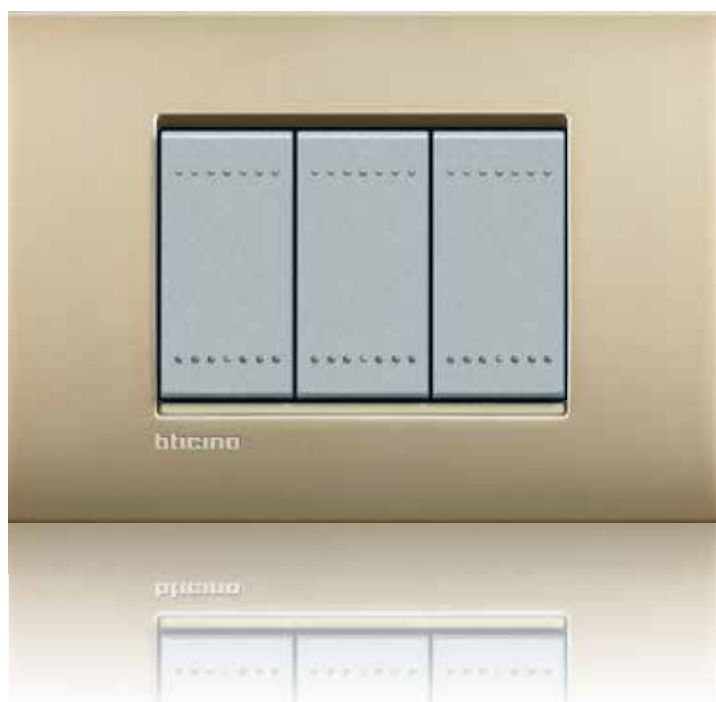

AIR COVER PLATES

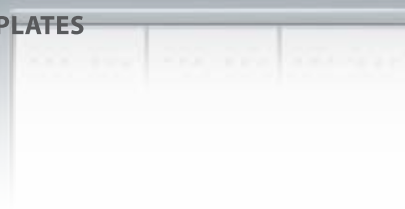



LIVING INTERNATIONAL COVER PLATES



LIGHT COVER PLATES

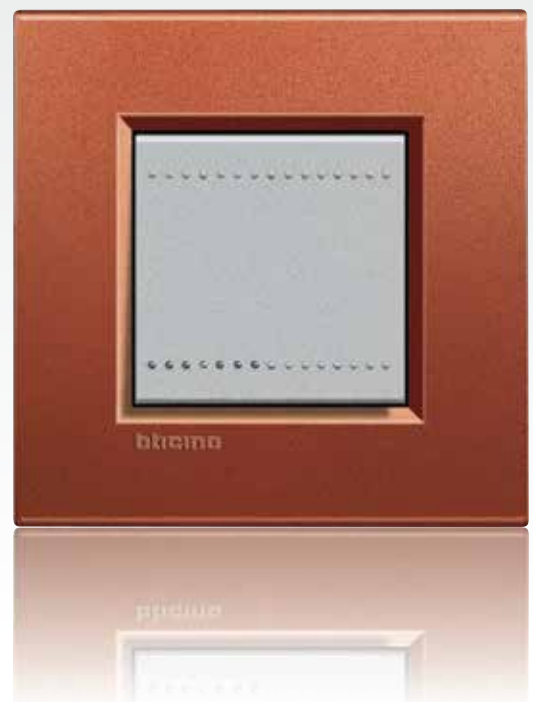
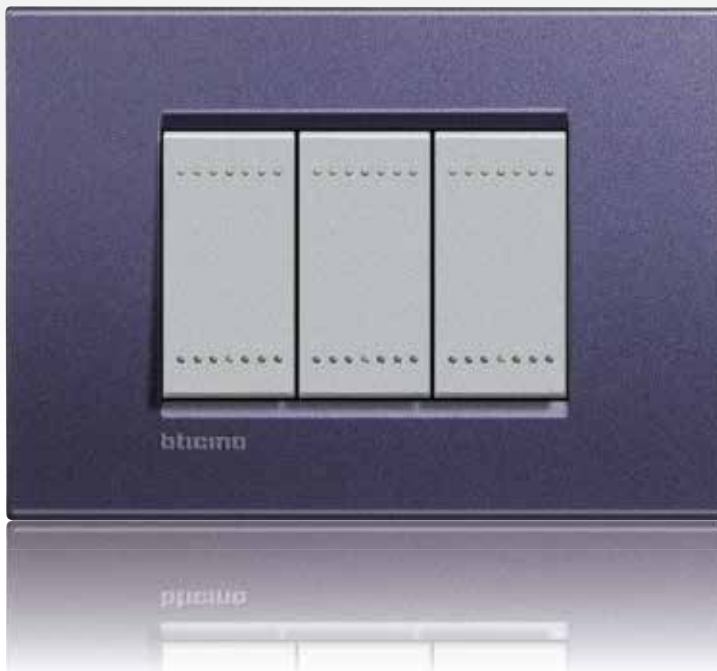

THE MOST FLEXIBLE AND MODERN PLATFORM

ALL POSSIBLE INSTALLATION



THE BEST PLATFORM

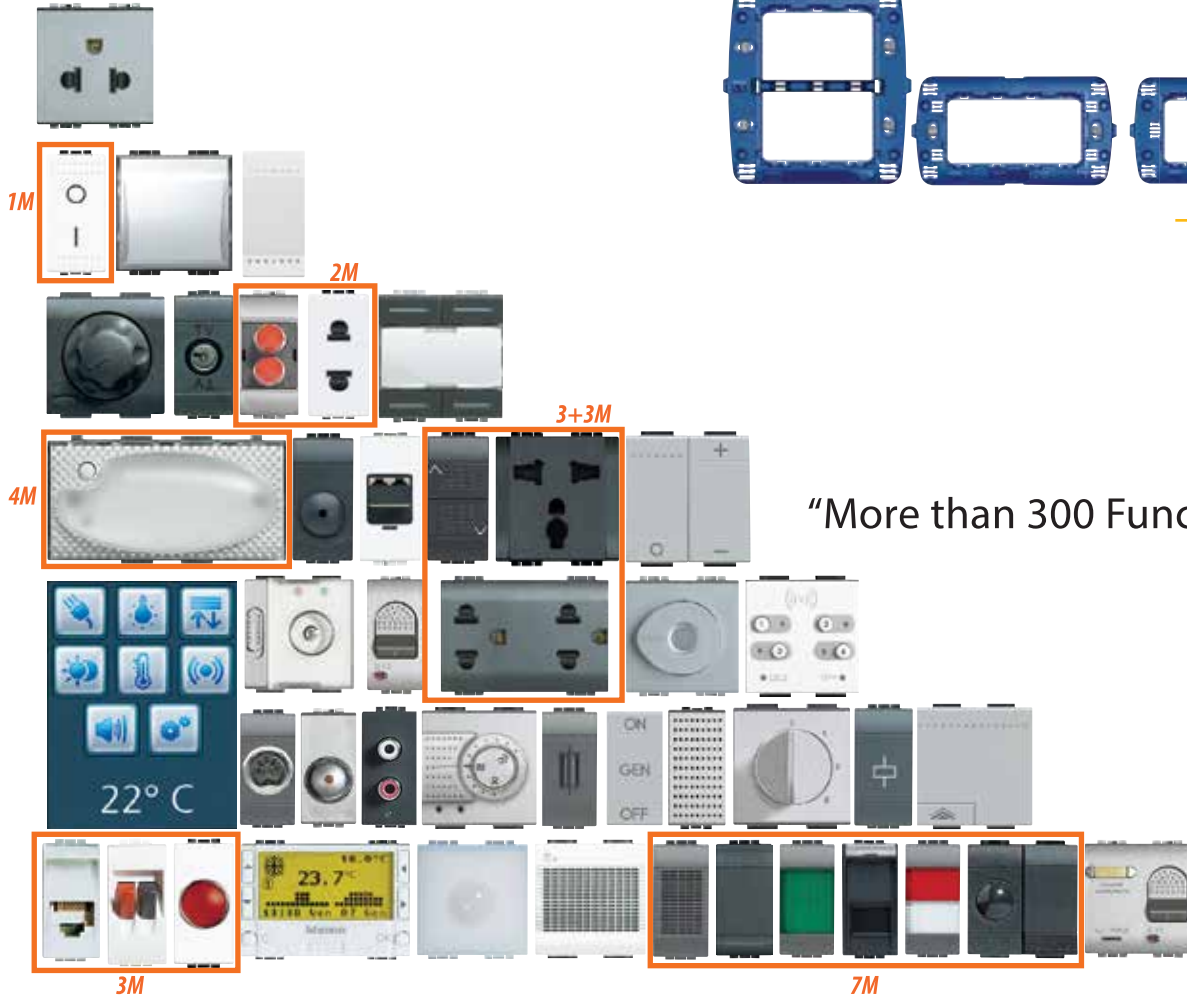
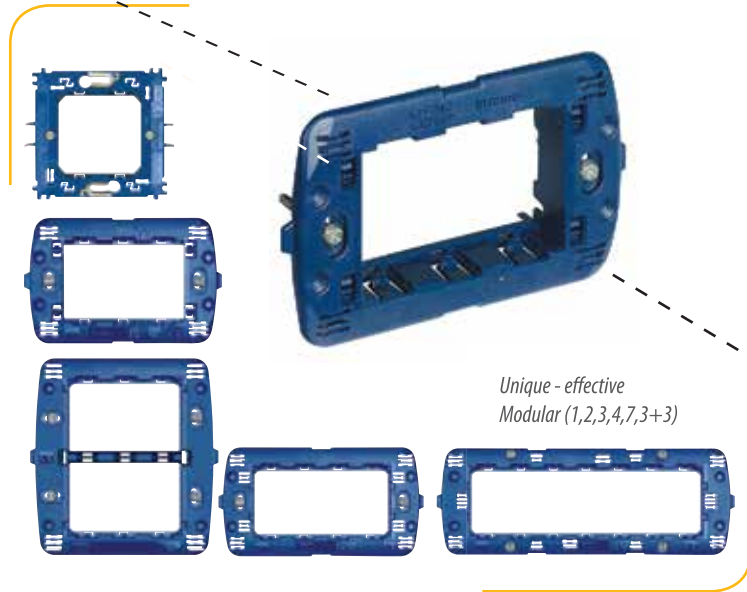

LIGHT

More modern lines resulting of the best trends of contemporary style.

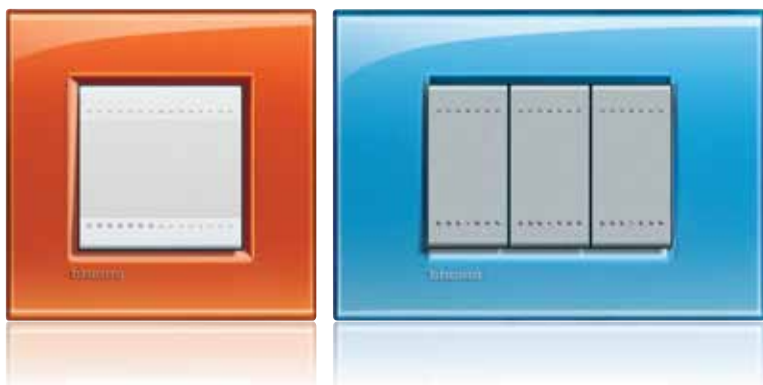

LIVING INTERNATIONAL

Soft and rounded shapes for a timeless design.



ALWAYS BE MODULAR



More than 300 functionalities

DESIGN: CHOOSE ITALIAN REFINEMENT



LIGHT cover plate

LIVING INTERNATIONAL cover plate

LIGHT^{AIR}

The thin art of perfection

Blue moon

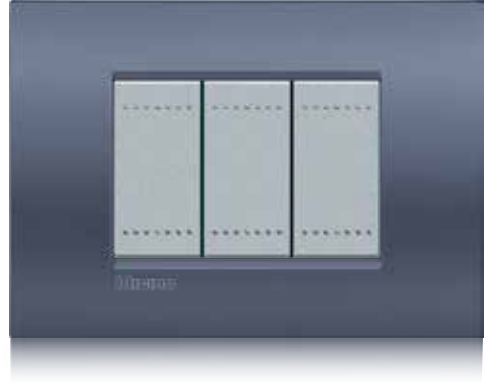

Satin gold



SOFT

Exclusive opaque finishes that harmonize perfectly with the current trends in interior design. (Street, Clay, Sand, Blue Moon)

Lava



BRIGHT

Finely treated metal for a reflective and satin surface (Peltrum, Palladium, Satin Gold, Satin Nickel).

NEUTRAL

Materials to match the finishes of the keys (Lava, Pearl white, Moon silver).



THE MOST ADVANCED SOLUTION SOLD IN MORE THAN 100 COUNTRIES

Door entry system



Switches



Temperature Control



Dimmer



Power socket



Weatherproof box



Scenario control unit



Switches

IN THE HOTEL LIKE AT HOME

A complete offer for a state of the art electric system also in the hotel room

➤ Maximum attention to customer requirements in terms of:

- available services
- comfort
- simple interaction with products and functions.

The BTicino Hotel range has been conceived for pleasant hotel stay, making guests feel as if they were in their own homes.



Inside the room: "do not disturb – make up the room" pushbuttons, and supply badge pocket (network ON)

IMMEDIATELY AT EASE

The presence of a badge holder socket invites the guest to immediately interact with the room services on offer. To be left undisturbed simply press the "do not disturb" control.



BEDSIDE PANEL



Thanks to the MY HOME scenario control at the side of the bed, a simple touch is enough to create the desired atmosphere, adjusting lights, temperature, blinds and curtains.



Razor socket



Path Markers Light



Emergency light



EACH FUNCTION CAN BE RECOGNISED IMMEDIATELY

A range of simple and intuitive symbols make each control recognisable and, and make it easier for the customer to interact with the available functions.



Curtain adjustment, Bedside and Master lights management

CONNECTION, ENTERTAINMENT, AND MULTIMEDIAITY

A range of products dedicated to audio/video connections provide the desired level of entertainment and relax.



HDMI and USB connector for managing readers and electronic devices such as DVDs, digital cameras, MP3 readers

TECHNOLOGY AND FLEXIBILITY IN THE OFFICE

The whole network at your fingertips: from electric distribution to the structured cabling for the management of data and audio/video signals

MAXIMUM INTEGRATION

LIVINGLIGHT can be installed in all the Interlink solutions: column, workstations, protruding towers and underfloor boxes.



Pop up



Workstation



Desk workstation



New RJ45 toolless connectors



Wi-Fi Access Point

MEETING ALL CONNECTION NEEDS

Full design coordination of LIVINGLIGHT with various systems:

- BTNET, structured cabling system
- distribution of data and audio/video signals
- wireless extension of the data network with Wi-Fi Access Point.



Green Switch/ Audio and video connectors/ Dimmer

CONTENTS



**WIRING DEVICES
CATALOGUE**

Basic control devices _____	10
Metal key covers _____	11
Other control devices _____	12
Green switch and electronic control devices _____	13
Dimmers _____	14
Socket outlets _____	16
TV-telephone sockets & RJ connectors _____	17
Audible and luminous signalling devices _____	18
Electrical safety devices/ Temperature control _____	19
Multimedia sockets _____	20
Hotel offer range _____	21
Accessories _____	22
Special installation _____	24
Light cover plates _____	26
Kristall cover plates _____	29
Living international cover plates _____	30
LIGHT ^{AIR} cover plates _____	32
Installation system _____	34

NOTE: the new codes are shown in the catalogue in orange.

BASIC CONTROL DEVICES

ROCKER CONTROLS

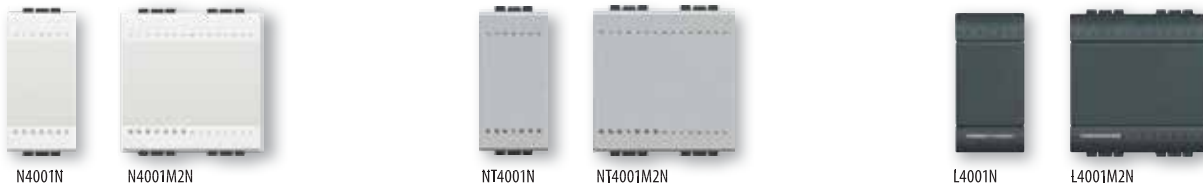

		1 WAY SWITCH 1P 16 AX 250Vac	2 WAY SWITCH 1P 16 AX 250Vac	4 WAY SWITCH 1P 16 AX 250Vac	PUSHBUTTON 1P (NO) 10 A 250Vac	PUSHBUTTON 1P (NC) 10 A 250Vac	PUSHBUTTON 2P (NO) 10 A 250Vac with independent contacts
1 MODULE	<input type="checkbox"/>	N4001N	N4003N	N4004N	N4005N	N4034N	N4044N
	<input type="checkbox"/>	NT4001N	NT4003N	NT4004N	NT4005N	NT4034N	NT4044N
	<input type="checkbox"/>	L4001N	L4003N	L4004N	L4005N	L4034N	L4044N
2 MODULE	<input type="checkbox"/>	N4001M2N	N4003M2N	N4004M2N	N4005M2N		
	<input type="checkbox"/>	NT4001M2N	NT4003M2N	NT4004M2N	NT4005M2N		
	<input type="checkbox"/>	L4001M2N	L4003M2N	L4004M2N	L4005M2N		
3 MODULE	<input type="checkbox"/>	L4001/0 + N4915M3N	L4003/0 + N4915M3N	LN4004 + N4915M3N	L4005/0 + N4915M3N		
	<input type="checkbox"/>	L4001/0 + NT4915M3N	L4003/0 + NT4915M3N	LN4004 + NT4915M3N	L4005/0 + NT4915M3N		
	<input type="checkbox"/>	L4001/0 + L4915M3N	L4003/0 + L4915M3N	LN4004 + L4915M3N	L4005/0 + L4915M3N		

AXIAL CONTROLS



		1 WAY SWITCH 1P 16 AX 250 Vac	2 WAY SWITCH 1P 16 AX 250Vac	4 WAY SWITCH 1P 16 AX 250Vac	PUSHBUTTON 1P (NC) 10A 250Vac
1 MODULE	<input type="checkbox"/>	N4051N	N4053N	N4054	N4055N
	<input type="checkbox"/>	NT4051N	NT4053N	NT4054	NT4055N
	<input type="checkbox"/>	L4051N	L4053N	L4054	L4055N
2 MODULE	<input type="checkbox"/>	N4051M2N	N4053M2N	N4054M2	N4055M2N
	<input type="checkbox"/>	NT4051M2N	NT4053M2N	NT4054M2	NT4055M2N
	<input type="checkbox"/>	L4051M2N	L4053M2N	L4054M2	L4055M2N

NEUTRAL CONTROLS

1 WAY SWITCH 1P 16 AX 250Vac	2 WAY SWITCH 1P 16 AX 250Vac	4 WAY SWITCH 1P 16 AX 250Vac	PUSHBUTTON 1P (NO) 10 A 250Vac
L4001/0	L4003/0	LN4004	L4005/0



L4001/0

NEUTRAL LIGHTABLE KEY COVERS

Description	1 module		2 modules	3 module
		item	item	item
NEUTRAL KEY COVER WITH LIGHTABLE BOTTOM SECTION	<input type="checkbox"/>	N4915N	N4915M2N	N4915M3N
	<input type="checkbox"/>	NT4915N	NT4915M2N	NT4915M3N
	<input type="checkbox"/>	L4915N	L4915M2N	L4915M3N
KRISTALL CUSTOMIZABLE TRANSPARENT KEY COVER	<input type="checkbox"/>	N4932	N4932/2	N4932/3



METAL KEY COVERS

		METAL KEY COVER WITH LIGHTABLE BOTTOM SECTION 4 FINISHES FOR USE WITH SQUARE METALS COVER PLATES		
		1 module	2 modules	3 module
Finish Description		item	item	item
ICE GOLD	○	LN49310A	LN4931M20A	LN4931M30A
BRONZE	○	LN4931BZ	LN4931M2BZ	LN4931M3BZ
NICKEL	○	LN4931NS	LN4931M2NS	LN4931M3NS
SILVER	○	LN4931AG	LN4931M2AG	LN4931M3AG
GOLD	○	LN49310C	LN4931M20C	LN4931M30C
DARK STEEL	○	LN4931AC	LN4931M2AC	LN4931M3AC
TITANIUM	○	LN4931TC	LN4931M2TC	LN4931M3TC
CHROME	○	LN4931CR	LN4931M2CR	LN4931M3CR



CUSTOMIZED KEY COVER

Key cover with 3 zones to be customized

	1 Module	2 Modules	3 Modules
1 Module	□ N4915NC	□ N4915M2NC	□ N4915M3NC
	■ NT4915NC	■ NT4915M2NC	■ NT4915M3NC
	■ L4915NC	■ L4915M2NC	■ L4915M3NC

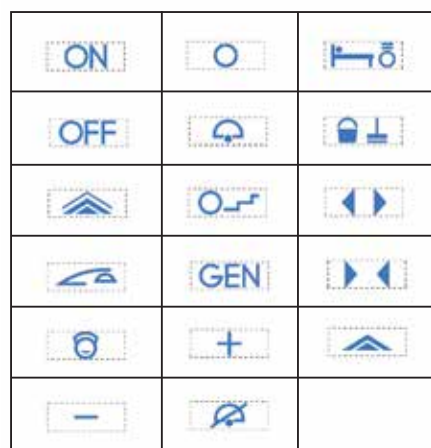
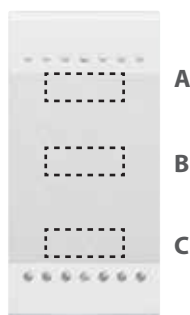

HOW TO BUILD A 3 MODULE 1 WAY SWITCH



OTHER CONTROL DEVICES



N4002N N4012 N4011



L4038R L4038V NT4033 L4037

16 AX 250 Va.c. DOUBLE-POLE SWITCH	
<input type="checkbox"/> N4002N <input type="checkbox"/> NT4002N <input type="checkbox"/> L4002N	2 P switch
<input type="checkbox"/> N4012 <input type="checkbox"/> NT4012 <input type="checkbox"/> L4012	2 P key switch - the key can be removed both in the ON and in the OFF position - keys are different from each other
<input type="checkbox"/> N4012C* <input type="checkbox"/> NT4012C* <input type="checkbox"/> L4012C*	2 P key switch - as above - keys are the same for all devices

* NOTE: item available to order. Contact your supplier for availability

32 A DOUBLE-POLE SWITCH	
<input type="checkbox"/> N4011 <input type="checkbox"/> NT4011 <input type="checkbox"/> L4011	32 A - 250 Va.c. 2P switch

10 A 250 Va.c. PUSHBUTTONS	
<input type="checkbox"/> N4036 <input type="checkbox"/> NT4036 <input type="checkbox"/> L4036	1 P (NO) + 1 P (NO) double pushbutton
<input type="checkbox"/> N4037 <input type="checkbox"/> NT4037 <input type="checkbox"/> L4037	1 P (NO) + 1 P (NO) interlocked double pushbutton
<input type="checkbox"/> N4033 <input type="checkbox"/> NT4033 <input type="checkbox"/> L4033	1 P (NO) cord pushbutton
<input type="checkbox"/> N4038R <input type="checkbox"/> NT4038R <input type="checkbox"/> L4038R	1 P (NO) pushbutton + lampholder for LEDs item LN4742V12T - LN4742V127T - LN4742V230T - red diffuser
<input type="checkbox"/> N4038V <input type="checkbox"/> NT4038V <input type="checkbox"/> L4038V	as above - green diffuser



NT4022 NT4027 NT4016



LN4040

16 AX 250 Va.c. TWO-WAY SWITCH	
<input type="checkbox"/> N4022 <input type="checkbox"/> NT4022 <input type="checkbox"/> L4022	1 P key switch - the key can be removed both in the ON and in the OFF position - keys are different from each other
<input type="checkbox"/> N4022C* <input type="checkbox"/> NT4022C* <input type="checkbox"/> L4022C*	1 P key switch - as above - keys are the same for all devices

* NOTE: item available to order. Contact your supplier for availability

<input type="checkbox"/> LN4040	1 P (NO) pushbutton + lightable nameplate with LEDs item LN4742V12T - LN4742V127T - LN4742V230T
---------------------------------	---



NT4341/34 NT4330/230

ROTARY SWITCH	
<input type="checkbox"/> N4016 <input type="checkbox"/> NT4016 <input type="checkbox"/> L4016	selector - 1 way rotary switch - 4 positions for controlling air conditioners, fans control, etc. - 3 A 250 Va.c.



MONOSTABLE RELAYS	
<input type="checkbox"/> N4330/230 <input type="checkbox"/> NT4330/230 <input type="checkbox"/> L4330/230	monostable relay with NO/NC contact 250 Va.c. 10 A (resistive) 4 A (inductive) cosφ 0.5 coil power supply 230 Va.c.



16A 250 Va.c. CHANGEOVER SWITCH	
<input type="checkbox"/> N4027 <input type="checkbox"/> NT4027 <input type="checkbox"/> L4027	1 P 1-0-2 double - key changeover switch

ELECTRONICALLY HELD CYCLIC RELAYS	
<input type="checkbox"/> N4341/34 <input type="checkbox"/> NT4341/34 <input type="checkbox"/> L4341/34	circuit breaker cyclic relay 10 AX 250 Va.c. - 3/4 wires

GREEN SWITCH AND ELECTRONIC CONTROL DEVICES



Item	GREEN SWITCH
<input type="checkbox"/> N4433N <input type="checkbox"/> NT4433N <input checked="" type="checkbox"/> L4433N	 Green Switch: switch with movement sensor, through a combination of passive infrared rays and ultrasounds , and brightness sensor. Manual switching on of the light using the front pushbutton, and automatic switching off based on brightness levels and movement. Switch off delay and brightness sensor threshold adjustable using the one/two-way (BMSO4003 and BMSO4001) remote control, 230 Va.c. power supply.- 2.5 A relay output – 2 modules
<input type="checkbox"/> N4434N <input type="checkbox"/> NT4434N <input checked="" type="checkbox"/> L4434N	 Green Switch: switch with passive infrared movement sensor – brightness sensor with adjustable threshold and adjustable switch off delay time - manual switching on of the light using the front pushbutton, and automatic switching off based on brightness levels and movement – 2.5 A resistive/inductive relay output – 230 Va.c. power supply - 2 modules
<input type="radio"/> BMSO4001	two-way IR remote control for the selection of the N/NT/L4434N sensor parameters. The device is fitted with a display for the acquisition of the currently set values, and the modification of the main parameters, such as: brightness level, switch off delay time, operating mode and sensitivity.
<input type="radio"/> BMSO4003	one-way IR remote control for the selection of the N/NT/L4434N sensor parameters. It enables the selection of the main parameters, such as: brightness level, switch off delay time, operating mode and sensitivity.

Item	PASSIVE IR SWITCHES
<input type="checkbox"/> N4431 <input type="checkbox"/> NT4431 <input checked="" type="checkbox"/> L4431	 switch with passive IR movement detector – adjustable threshold twilight circuit with possibility of exclusion – switch off time delay circuit, adjustable from 3 seconds to 10 minutes – relay output 2 A resistive / 2 A inductive – power supply 230 Va.c. - 1 module
<input type="checkbox"/> N4432 <input type="checkbox"/> NT4432 <input checked="" type="checkbox"/> L4432	 as above – switch off delay time circuit, with delay adjustment from 30 seconds to 10 minutes - it can also be activated using the external pushbutton - relay output 6 A resistive/2 A inductive - with 0-A-I selector - power supply 230 Va.c.- 2 modules

NOTE: for more information on remote controls BMSO4003 and BMSO4001 refer to the Lighting Management Catalogue.

NOTE: White colour device Tech colour device Anthracite colour device Neutral item

GREEN SWITCH: ILLUMINATION ONLY WHEN NEEDED

Green Switch is the intelligent solution for **managing lighting without waste** in the residential and service sectors.



ECO MODE

The load is switched on manually and switched off automatically by the sensor, depending on the daylight level and the presence detection.

You choose to switch on the light



1) Light level detection
2) Presence detection



Auto off

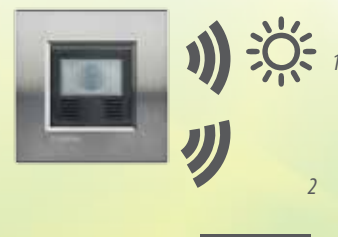

AUTO MODE

The switching on and off of the load are ordered automatically by the sensor, depending on movement detection and the desired lighting levels.

Presence detection

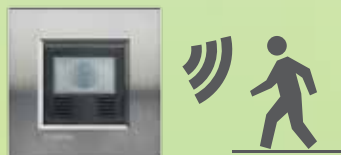

Light level detection



Auto off

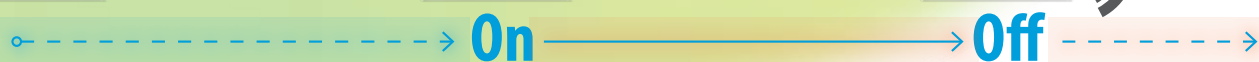

UP TO 55% SAVINGS
IN COMPLIANCE WITH EN15193 STANDARD

DIMMERS

For an efficient management of all types of loads

NEW

NEW UNIVERSAL DIMMER

With the new BTicino universal dimmers it is possible to control and adjust the light intensity of all types of loads on the market, from traditional incandescent lamps, to the latest generation LED and CFL energy saving lamps that, as required by the regulations, will soon replace them.



COMFORT:

- thanks to the new universal dimmer, it is possible to adjust the light intensity, obtaining the optimum light conditions for each situation
- its ergonomics and the user interface are simple and intuitive, with dedicated pushbuttons for switching on/off, and +/- level adjustment
- a simple touch is enough to switch the light on at a preset level (33% or 66%)

INSTALLATION ADVANTAGES:

- thanks to the possibility of managing all kinds of loads, the device may be installed before selecting the lamps
- wiring only requires 2 wires (no neutral wire necessary), saving time during the installation
- as the neutral is not necessary, it can be easily installed in replacement of traditional existing dimmers or controls
- it can be controlled by one or more remote pushbuttons

ADD PUSH BUTTONS FOR MORE CONTROL POINTS



Dimmer Control



Additional push button

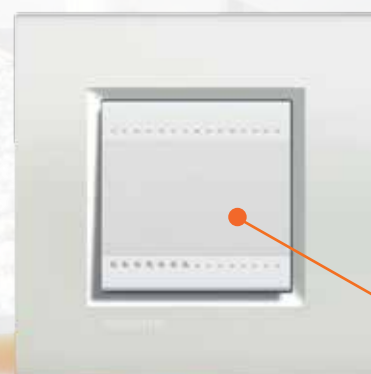

Additional push button

"Press and dim"

DIMMERS



N4402N



NT4408N
NT4410N
NT4411N

Item	KNOB DIMMER
□ N4402N*	 knob dimmer with built-in two way switch - resistive 60-500 W - TRIAC/IGBT technology - built-in fuse - 1 module
■ NT4402N*	
■ L4402N*	

Item	TOUCH DIMMER
□ N4408N	 resistive/inductive touch dimmer 300/600 W with electronic protection - 2 modules
■ NT4408N	
■ L4408N	

Item	UNIVERSAL PUSHBUTTON DIMMER
□ N4411N	 universal dimmer (resistive - inductive, capacitive, fluorescent compact and dimmer LEDs) - 150/200/400 W with electronic protection - 2 modules
■ NT4411N	
■ L4411N	

*NOTE: when installing dimmers with AIR plates, for optimum look result and planarity of the light point, the use of the new pushbutton dimmers is recommended (E.g. L/N/NT4411N). Alternatively, if installing the L/N/NT4002N and L/N/NT4406, the use of the box extension is recommended, as it will make wiring easier.

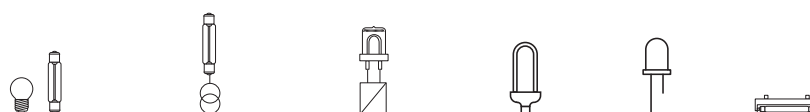
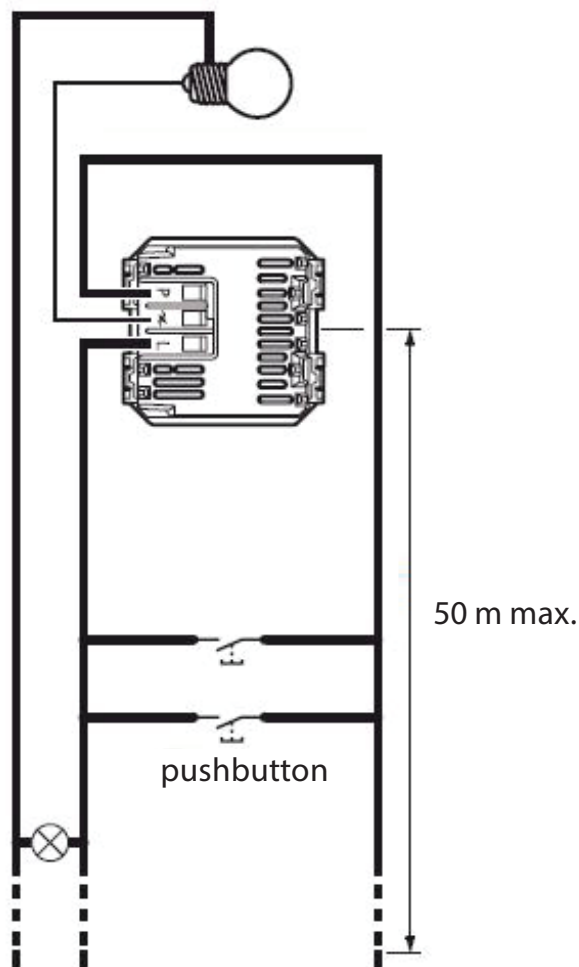

Loads

Item	Type	range	supply std	Incandescents and hogenens	Halogens with ferromagnetic transformer	Halogens with electronic transformer	Dimmerable compact fluorescents	Dimmerable LED lamps	Fluorescents with electronic 0-10 V ballast
N4402N NT4402N L4402N	Resistive	230 Va.c. 50 Hz	230 Va.c.	60 - 500 W					
N4408N NT4408N L4408N	Resistive Inductive	100 - 240 Va.c. 50 - 60 Hz	240 Va.c. 100 Va.c.	20 - 600 W 20 - 300 W	20 - 600 VA 20 - 300 VA				
N4411N NT4411N L4411N	Universal	100÷240 Va.c. 50÷60 Hz	240 Va.c. 100 Va.c.	3 ÷ 400 W 3 ÷ 200 W	3 ÷ 400 VA 3 ÷ 200 VA	3 ÷ 400 VA 3 ÷ 200 VA	3 - 150 VA 3 - 75 VA	3 - 150 VA 3 - 75 VA	

SOCKET OUTLETS

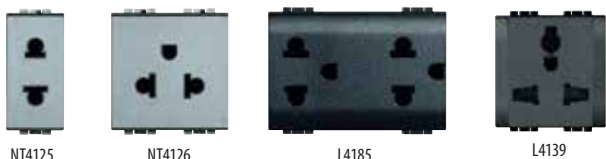

Item	EURO-AMERICAN STANDARD	
<input type="checkbox"/> N4129S <input checked="" type="checkbox"/> NT4129S <input checked="" type="checkbox"/> L4129S		2 P+E 15 A 127/250 Va.c. socket - unshielded tulip contacts - 1 module
<input type="checkbox"/> N4125 <input checked="" type="checkbox"/> NT4125 <input checked="" type="checkbox"/> L4125		2 P 16 A 127/250 Va.c. socket - Ø 5 mm shielded tulip contacts - 1 module
<input type="checkbox"/> N4126 <input checked="" type="checkbox"/> NT4126 <input checked="" type="checkbox"/> L4126		2 P+E 16 A 127/250 Va.c. universal simplex socket - Ø 5 mm unshielded tulip contacts - 2 modules
<input type="checkbox"/> N4185 <input checked="" type="checkbox"/> NT4185 <input checked="" type="checkbox"/> L4185		2 P+E 16 A 127/250 Va.c. universal duplex socket - shielded tulip contacts - 3 modules
COLORED SOCKET		
<input checked="" type="checkbox"/> N4185R		2 P+E 16 A 127/250 Va.c. universal duplex socket - shielded tulip contacts - 3 modules colour red
<input type="checkbox"/> L4140/16R		2 P+E 16 A 250 Va.c. socket - centre distance 19 mm contacts ; earth side contacts for German standard plugs; suitable for: 2 P and 2 P+E 10/16 A Italian standard plugs, 2 P+E 16 A German standard plugs - colour red
MULTISTANDARD		
<input type="checkbox"/> N4139 <input checked="" type="checkbox"/> NT4139 <input checked="" type="checkbox"/> L4139		2 P+E 5/6/10/13 A 250 Va.c. and 127 Va.c. socket - multistandard - 2 modules
<input type="checkbox"/> N4140/16 <input checked="" type="checkbox"/> NT4140/16 <input checked="" type="checkbox"/> L4140/16		2 P+E 16 A 250 Va.c. socket - centre distance 19 mm and 26 mm in 2-centre configuration - protected tulip contacts ; earth side contacts for German standard plugs; suitable for: 2 P and 2 P+E 10/16 A Italian standard plugs, 2 P+E 16 A German standard plugs

USB CHARGER	
<input type="checkbox"/> N4285C1 <input checked="" type="checkbox"/> NT4285C1 <input checked="" type="checkbox"/> L4285C1	USB connector 5 Vd.c. to recharge electronic devices as mobiles, smartphone, tablet and similar, up to 1,100mA. Power supply 230 Va.c.
<input type="checkbox"/> N4285C2 <input checked="" type="checkbox"/> NT4285C2 <input checked="" type="checkbox"/> L4285C2	USB connector 5 Vd.c. to quick recharge of a single electronic devices as mobiles, smartphone, tablet and similar, up to 2,400 mA, or simultaneous recharge of two devices up to 1,200 mA. Power supply 230 Va.c.

INDUCTION CHARGER	
<input type="checkbox"/> LN4285CW2	Induction charger, with 2.400 mA USB charging port. It allows fast and wireless charging of smartphones equipped with an induction receiver. Suitable for bed head, sideboards, desks, work environments. Complies with the WPC Qi standard (World Power Consortium) and the EN62479 standard (ECM emission). It meets the needs of people's protection in the field of electromagnetic fields and does not disturb other radio transmissions (Zigbee, TNT, GSM 4G, ...). It is equipped with 2 50x80 mm induction antennas that guarantee a quick coupling of the smartphone. The anti-slip surface is inclined by 10 °. Anti-theft "lock" function. Energy efficiency > 85%. Equipped with a 2400 mA type A USB port to power a second device. 12W. Size 136.5 x 70 x 56.5 mm

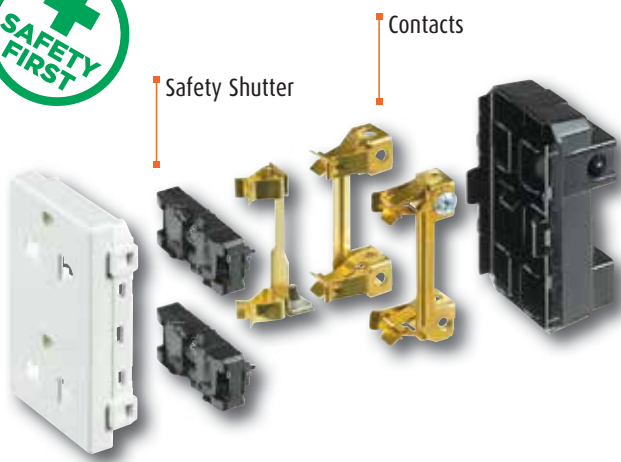

TV - TELEPHONE SOCKETS



Item	STANDARD TV SOCKETS
<input type="checkbox"/> N4269T	shunted coaxial jack antenna system - 1 mod (Female)
<input type="checkbox"/> NT4269T	
<input type="checkbox"/> L4269T	

Item	SCREENED TV SOCKETS
<input type="checkbox"/> LN4202D	shunted coaxial jack - Ø 9.5 mm - male jack - 1 module - screened TV + SAT sockets in die-casting housing with current flow

Item	TYPE F TV SOCKETS
<input type="checkbox"/> LN4202F	type F TV female connector - 75 Ω impedance - screw coupling - 1 modules

Item	PLUGS AND TERMINAL RESISTANCE
<input type="checkbox"/> S2133	mobile TV plug and jack - Ø 9.5 mm - white - for TV + SAT jacks and L/N/NT4206D
<input type="checkbox"/> 75RTN	terminal resistance for lines closing with 75 Ω impedance in installations with cascade connection - to be added to the last pass-through jack

TELEPHONE CONNECTORS

Item	RJ11 TELEPHONE CONNECTORS	
<input type="checkbox"/> N4258/11N	These connectors have been designed for meeting the requirements of telephone connections.	
<input type="checkbox"/> NT4258/11N		
<input type="checkbox"/> L4258/11N		
	Jack type	Connection type
	RJ11	Toolless

EFFECTIVE - EXCLUSIVE

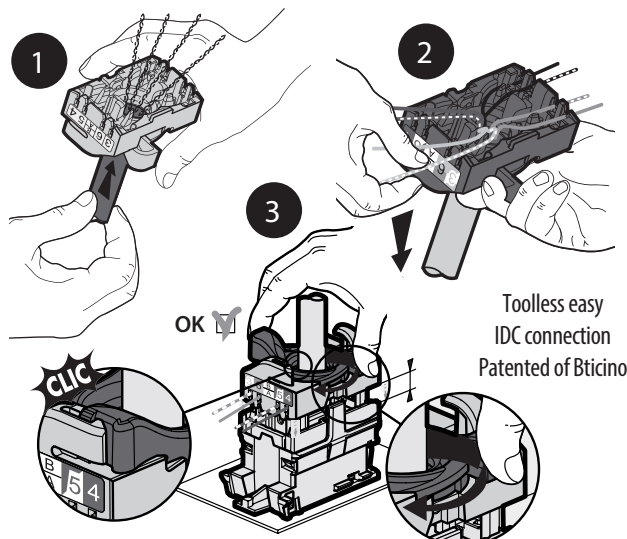

RJ CONNECTORS



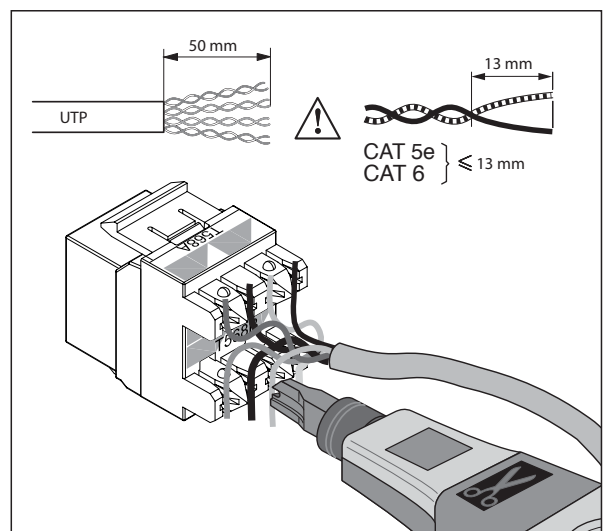

Item	RJ45 CONNECTORS (UTP)		
	RJ 45 data transmission/telephone connectors. Specially designed for data and telephone transmission. These connectors are widely used for computer networks with a 4-pair cable.		
	Category	Connection type	
<input type="checkbox"/> N4279C5E	5E	BTicino (ITALY) Socket	Toolless easy IDC Connection Exclusive patented of Bticino
<input type="checkbox"/> NT4279C5E			
<input type="checkbox"/> L4279C5E			
<input type="checkbox"/> N4279C6	6	BTicino (ITALY) Socket	Toolless easy IDC Connection Exclusive patented of Bticino
<input type="checkbox"/> NT4279C6			
<input type="checkbox"/> L4279C6			
<input type="checkbox"/> N4279C6A	6A	BTicino (ITALY) Socket	Toolless easy IDC Connection Exclusive patented of Bticino
<input type="checkbox"/> NT4279C6A			
<input type="checkbox"/> L4279C6A			
<input type="checkbox"/> N4262C5E	5E	ORTRONICS (USA) Socket Keystore attach	110 IDC classic connection
<input type="checkbox"/> NT4262C5E			
<input type="checkbox"/> L4262C5E			
<input type="checkbox"/> N4262C6	6	ORTRONICS (USA) Socket Keystore attach	110 IDC classic connection
<input type="checkbox"/> NT4262C6			
<input type="checkbox"/> L4262C6			
<input type="checkbox"/> N4261AT5	5E	ORTRONICS (USA) Socket Keystore attach	110 IDC classic connection
<input type="checkbox"/> NT4261AT5			
<input type="checkbox"/> L4261AT5			
<input type="checkbox"/> N4261AT6	6	ORTRONICS (USA) Socket Keystore attach	110 IDC classic connection
<input type="checkbox"/> NT4261AT6			
<input type="checkbox"/> L4261AT6			

110 IDC classic connection



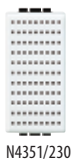



AUDIBLE AND LUMINOUS SIGNALLING DEVICES



Item	BELLS
<input type="checkbox"/> N4351/230 <input checked="" type="checkbox"/> NT4351/230 <input checked="" type="checkbox"/> L4351/230	 bronze bell 230 Va.c. - 8 VA - 80 dB - 50 and 60 Hz
<input type="checkbox"/> N4355/12 <input checked="" type="checkbox"/> NT4355/12 <input checked="" type="checkbox"/> L4355/12	 electronic bell - 3 different sounds - with front volume adjustment - 12 Va.c./d.c. - 2 modules

Item	BUZZERS
<input type="checkbox"/> N4356/230 <input checked="" type="checkbox"/> NT4356/230 <input checked="" type="checkbox"/> L4356/230	 buzzer 230 Va.c. - 8 VA - 75 dB - 50 and 60 Hz

Item	PILOT LIGHTS
<input type="checkbox"/> N4371T <input checked="" type="checkbox"/> NT4371T <input checked="" type="checkbox"/> L4371T	 lampholder with transparent diffuser - for LED items LN4742V12T, LN4742V127T and LN4742V230T
<input type="checkbox"/> N4371R <input checked="" type="checkbox"/> NT4371R <input checked="" type="checkbox"/> L4371R	 lampholder with red diffuser - for LED items LN4742V12T, LN4742V127T and LN4742V230T
<input type="checkbox"/> N4371V <input checked="" type="checkbox"/> NT4371V <input checked="" type="checkbox"/> L4371V	 lampholder with green diffuser - for LED items LN4742V12T, LN4742V127T and LN4742V230T
<input type="checkbox"/> N4372AV <input checked="" type="checkbox"/> NT4372AV <input checked="" type="checkbox"/> L4372AV	 double lampholder with 2 diffusers: 1 orange + 1 green - for 2 LED items LN4742V12T, LN4742V127T and LN4742V230T

PUSH BUTTON OUTSIDE ...

... BUZZER OR BELL INSIDE



LN 4040



Choose between 3 ringtones



ELECTRICAL SAFETY DEVICES



N4301/6



L4356

Item	AUTOMATIC THERMAL MAGNETIC CIRCUIT BREAKERS	
<input type="checkbox"/> N4301/6 <input type="checkbox"/> NT4301/6 <input type="checkbox"/> L4301/6		two-pole automatic thermal magnetic circuit breakers with a 6 A 230 Va.c. protected pole - indicator of open/closed contacts - breaking capacity 1500 A 230 Va.c.
<input type="checkbox"/> N4301/10 <input type="checkbox"/> NT4301/10 <input type="checkbox"/> L4301/10		circuit breakers as above 10 A - breaking capacity 3000 A 230 Va.c.
<input type="checkbox"/> N4301/16 <input type="checkbox"/> NT4301/16 <input type="checkbox"/> L4301/16		circuit breakers as above 16 A - breaking capacity 3000 A 230 Va.c.

FUSE CARRIERS		
<input type="checkbox"/> N4321 <input type="checkbox"/> NT4321 <input type="checkbox"/> L4321		fuse carrier for fuses 5x20 and 6.3x 32 - max. 10 250 Va.c.
<input type="checkbox"/> N4322 <input type="checkbox"/> NT4322 <input type="checkbox"/> L4322		fuse carrier for 16 A

SURGE PROTECTIVE DEVICES		
<input type="checkbox"/> N4536 <input type="checkbox"/> NT4536 <input type="checkbox"/> L4536		1 P surge protective devices to be combined with the users mains socket - rated discharge voltage $I_n=1$ kA - max. current $I_{max}=2$ kA - max. protection voltage $U_p=1$ kV - rated voltage $U_n=110-230$ Va.c. - max. permanent voltage $U_c=250$ Va.c.

TEMPERATURE CONTROL



N4441



N4451



L4450

Item	ELECTRONIC THERMOSTATS	
<input type="checkbox"/> N4441 <input type="checkbox"/> NT4441 <input type="checkbox"/> L4441		electronic room thermostat - relay output with 1 switching contact 2 A 250 Va.c. - power supply 230 Va.c.

TIMER THERMOSTATS		
<input type="checkbox"/> N4451 <input type="checkbox"/> NT4451 <input type="checkbox"/> L4451		flush mounted daily/weekly timer thermostat for heating and cooling systems. Three selectable temperatures during the 24 h period - Auto, Manual, Holiday, Antifreeze Operation. Backlighted display - power supply with battery: 2 x 1.5 V - remote activation using the remote control - possibility of connecting an external probe - output: contact in exchange 5(3) A
<input type="checkbox"/> N4450 <input type="checkbox"/> NT4450 <input type="checkbox"/> L4450		wall mounted daily/weekly electronic timer thermostat for heating and cooling systems. Three selectable temperatures during the 24 h period - Auto, Manual, Holiday, Jolly, Antifreeze Operation. Power supply with battery: 2x1.5 V - possibility of connecting an external temperature probe - output contact in exchange 1 A cosφ 0.5



INTERNATIONAL SOCKET,
BEST SOLUTION FOR INTERNATIONAL BUSINESS

SURGE PROTECTION,
PROTECT YOUR DEVICE

CIRCUIT BREAKER,
SAFETY FIRST ALSO AT THE OFFICE

MULTIMEDIA SOCKETS



N4294



NT4268ST



NT4268LC



NT4285



L4262/11



L4269R

Item	AUDIO VIDEO CONNECTORS	
<input type="checkbox"/> N4269R <input type="checkbox"/> NT4269R <input type="checkbox"/> L4269R		double RCA connector – red and yellow collars – terminations to be welded
<input type="checkbox"/> N4294 <input type="checkbox"/> NT4294 <input type="checkbox"/> L4294		connector for loudspeakers
<input type="checkbox"/> N4269HJT <input type="checkbox"/> NT4269HJT <input type="checkbox"/> L4269HJT		connector - jack 3.5
<input type="checkbox"/> N4269RWT <input type="checkbox"/> NT4269RWT <input type="checkbox"/> L4269RWT		connector - RCA x 2
<input type="checkbox"/> N4269VGAT <input type="checkbox"/> NT4269VGAT <input type="checkbox"/> L4269VGAT		connector - HD15
<input type="checkbox"/> N4269RWYT <input type="checkbox"/> NT4269RWYT <input type="checkbox"/> L4269RWYT		RCA x 3 connector
<input type="checkbox"/> N4269HDMIT <input type="checkbox"/> NT4269HDMIT <input type="checkbox"/> L4269HDMIT		HDMI connector
<input type="checkbox"/> N4269USBT <input type="checkbox"/> NT4269USBT <input type="checkbox"/> L4269USBT		USB connector

Item	SPECIAL CONNECTORS	
<input type="checkbox"/> N4292 <input type="checkbox"/> NT4292 <input type="checkbox"/> L4292		standard five pole DIN connector for HI-FI and similar – connection to be welded
<input type="checkbox"/> N4293 <input type="checkbox"/> NT4293 <input type="checkbox"/> L4293		2 pole DIN connector – connection to be welded

Item	CONNECTORS FOR OPTICAL FIBER CONNECTIONS	
<input type="checkbox"/> N4268ST <input type="checkbox"/> NT4268ST <input type="checkbox"/> L4268ST		coupling connector for optical fiber - ST cable socket - duplex
<input type="checkbox"/> N4268SC <input type="checkbox"/> NT4268SC <input type="checkbox"/> L4268SC		coupling connector for optical fiber - SC cable socket - duplex
<input type="checkbox"/> N4268LC <input type="checkbox"/> NT4268LC <input type="checkbox"/> L4268LC		connector for fiber - optic cable sealing and type LC - duplex

Item	VOLUME CONTROL	
<input type="checkbox"/> N4269VL <input type="checkbox"/> NT4269VL <input type="checkbox"/> L4269VL		Volume control



MULTIMEDIA AT HOME

HOTEL OFFER RANGE

This page lists the devices specifically intended for hotel room services.

The BTicino hotel room offer range, and in more general terms for the hotel sector, includes however many more devices that are also used in other sector, and are therefore listed in various sections throughout this catalogue.

Some of them are, for example:

- comfort devices = light, curtain, and scenario controls with dedicated symbols. Also, thermostats and temperature probs with knobs.
- audio and video devices = connectors for every need and sound signalling devices
- safety devices = step lights and emergency lamps.



L4545



LN4549



NT4547



N4033





N4177



N4373H





N4028H

Item	BADGE-HOLDER POCKET
<input type="radio"/> LN4549	 badge holder pocket for the power supply inside the hotel room - slot light with built-in lamp - 30 second switch-off delay - power supply 230 Va.c. - 2 modules - to be completed with front cover in the desired look
<input type="radio"/> LN4548	 badge holder pocket for the power supply inside the hotel room with RFID technology recognition - slot light with built-in lamp - 30 second switch-off delay - power supply 230 Va.c. - 2 modules - to be completed with front cover in the desired look

Item	LAMPHOLDER FOR OFF-DOOR SIGNALLING
<input type="checkbox"/> N4373H	 off-door lampholder with double optical signalling: do not disturb and make-up the room - use 2 LEDs item LN4742V12T (12 V)
<input type="checkbox"/> NT4373H	
<input type="checkbox"/> L4373H	

<input type="checkbox"/> N4028H	 changeover switch 1P 16A - 250V a.c. double pushbutton 1-0-2 for Hotel installation - room condition indication: "PLEASE DO NOT DISTURB" and "PLEASE MAKE UP THE ROOM". To use with pilot light item. Items conform to BS EN 60 669-1
<input type="checkbox"/> L4028H	

	FRONT COVERS FOR BADGE-HOLDER POCKETS
<input type="checkbox"/> N4547	 front cover for traditional or My Home badge-holder pocket - the installation is compatible with 2 module boxes only
<input type="checkbox"/> NT4547	
<input type="checkbox"/> L4547	
<input type="checkbox"/> N4551	 front cover for traditional or My Home badge-holder pocket - 3 modules
<input type="checkbox"/> NT4551	
<input type="checkbox"/> L4551	

	SHAVER SOCKETS
<input type="checkbox"/> N4177	 shaver socket with insulation transformer - input voltage 230 Va.c. @ 50/60 Hz - output voltage 115/230 Va.c. 20 VA
<input type="checkbox"/> NT4177	
<input type="checkbox"/> L4177	

*Note: when installed with Livinglight AIR, the use of the box extension is necessary, in order to make easy the wiring

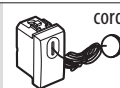
	CORD PUSHBUTTONS
<input type="checkbox"/> N4033	 cord pushbutton 1 P NO 10 A for bathroom alarm
<input type="checkbox"/> NT4033	
<input type="checkbox"/> L4033	



MULTIMEDIA AT THE HOTEL



CONNECTION AND ENTERTAINMENT
EVERYWHERE

ACCESSORIES



LN4742V12T



LN4742V230

Item	LEDs	
<input type="radio"/> LN4742V230 <input type="radio"/> LN4742V12		LED for rocker controls 230 V or 12/24 V - amber
<input type="radio"/> LN4742V230T <input type="radio"/> LN4742V12T		white LED for pilot lights and BS 230 V or 12/24 V devices
<input type="radio"/> LN4743/230A <input type="radio"/> LN4743/12A		LED for axial control 230 Va.c 12/24V - amber
<input type="radio"/> LN4743/230T <input type="radio"/> LN4743/12T		LED for axial control 230 Va.c 12/24V - White

BLANK PLATES



N4950



L4951

Item	BLANK PLATES	
<input type="checkbox"/> N4950 <input type="checkbox"/> NT4950 <input type="checkbox"/> L4950		blank plate - 1 module
<input type="checkbox"/> N4951 <input type="checkbox"/> NT4951 <input type="checkbox"/> L4951		blank plate with knockout - 2 modules
<input type="checkbox"/> N4953 <input type="checkbox"/> NT4953 <input type="checkbox"/> L4953		blank plate with output Ø 9 mm - with clamp - 1 module
<input type="checkbox"/> N4954 <input type="checkbox"/> NT4954 <input type="checkbox"/> L4954		blank plate with output Ø 9 mm - with clamp - 2 modules

LED SELECTION TABLE FOR DEVICE LIGHTING

Lightable devices / Item		What LEDs for lighting
Switches	Switches	
1 module	2 modules	
L4001/0		LN4742V12T (12/24 V) LN4742V230 (230 V)
L4003/0		
LN4004		
N/NT/L4001N	N/NT/L4001M2N	
N/NT/L4003N	N/NT/L4003M2N	
N/NT/L4004N	N/NT/L4004M2N	
N/NT/L4002N		
Pushbuttons		
N/NT/L4038R		LN4742V12T (12/24 V) LN4742V230T (230 V)
LN4040		
L4005/0		
N/NT/L4005N	N/NT/L4005M2N	
N/NT/L4044N		
Pilot light		
N/NT/L4371A		LN4742V12T (12/24 V) LN4742V230T (230 V)
N/NT/L4371T		
N/NT/L4371R		
N/NT/L4371V		
N/NT/L4372AV (2 LED)		
N/NT/L4372RT (2 LED)		
N/NT/L4373HN (2 LED)		
Axial control devices		
1 module	2 modules	
N/NT/L4051N	N/NT/L4051M2N	LN4743/12A/(12/24V)
N/NT/L4053N	N/NT/L4053M2N	LN4743/230A(230V)
N/NT/L4054N	N/NT/L4054M2N	LN4743/12T/(12/24V)
N/NT/L4055N	N/NT/L4055M2N	LN4743/230T(230V)

CONTROL BACKLIGHTING LED CONNECTION

Note for the connection of 230 V.a.c. LEDs for the backlighting of control devices: when LEDs are fitted to help locate the control itself, it must be taken into account that energy saving and fluorescent lamps do not allow in series connection of the LED on the load.

It is therefore necessary to also take a neutral conductor near the control, so that the LED may be connected directly between phase and neutral, and will always be on.

EXAMPLES OF LED CONNECTION ON A SWITCH

function: locating

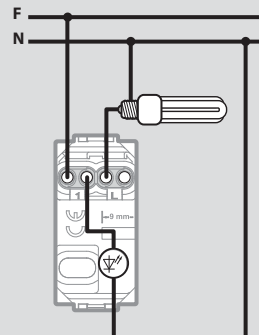

function: load status LED

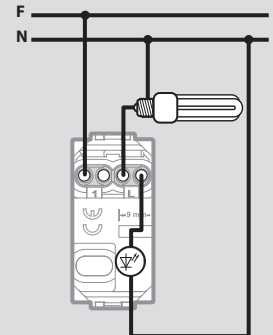

2 WIRES DOOR ENTRY SYSTEM

- From villa to small & medium condominium or compound
- Integrated with the most advanced home automation system

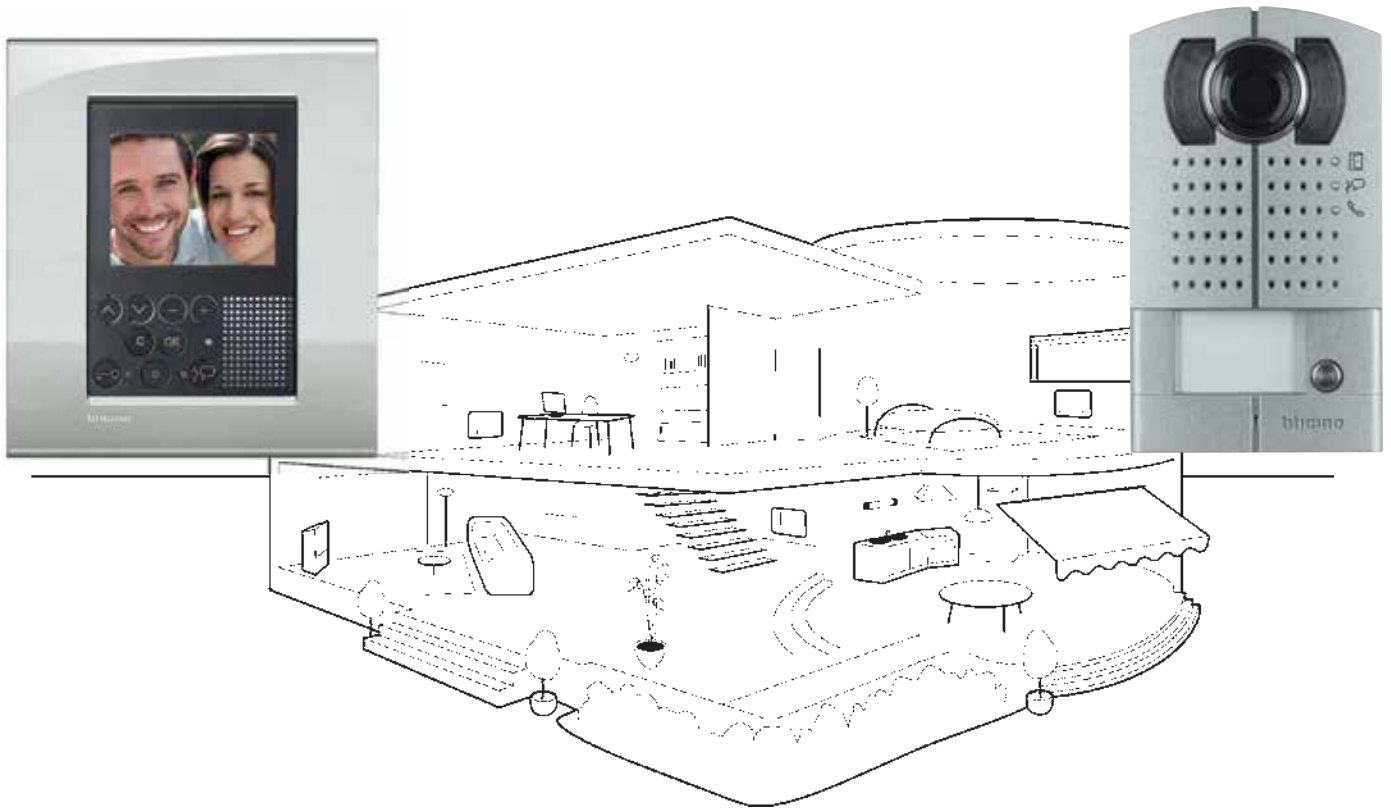

HOME AUTOMATION, THE NATURAL EVOLUTION OF YOUR HOME.



WITH A SINGLE TOUCH

- Turn on the light
- Switch off the air-con
- Open the curtains
- Put her favorite song on

BTicino let you **design** your homespace. A single impulse is now a **Scenario** fitting your **habits** and **desires**.

SPECIAL INSTALLATION



506L
(183.5x90x53.5 mm)



503E
(106x71x52 mm)



PB503N
(110x71x52 mm)
for plasterboard

Item	BOX FOR MASONRY WALL
502E	Plastic box 2 modules
502W	Living plastic box 2 modules - Light air
503E	Living plastic box 3 modules
504E	Living plastic box 4 modules
506L	Living plastic box 7 modules
510L	Living plastic box 1 module
506E	Living plastic box 6 modules
16102	Living plastic box 6x3 modules





Item	BOX FOR PLASTERBOARD WALL
PB502W	Plasterboard box 2 modules - Light air
PB502N	Plasterboard box 2 modules
PB503N	Plasterboard box 3 modules
PB504N	Plasterboard box 4 modules
PB526N	Plasterboard box 3+3 modules
PB506N	Box for plasterboard wall 7 modules

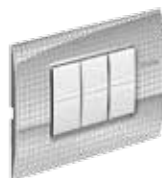

Box extension



LIVINGLIGHT AIR

Item	BOX EXTENSION
<input type="radio"/> 503ESE	 adapter, for increasing the depth of 503E flush mounted boxes
<input type="radio"/> 504ESE	 adapter, for increasing the depth of 504E flush mounted boxes
<input type="radio"/> 506LSE	 adapter, for increasing the depth of 506L flush mounted boxes
<input type="radio"/> 506ESE	 adapter, for increasing the depth of 506E flush mounted boxes

These adapters may be used when installing the box. They make wiring easier in case of several cables inside the same box, or for particularly deep devices.

Confer to page 35

WEATHERPROOF



24602N - white



24603L - anthracite

Item	IDROBOX IP55 - PROTECTED COVER
<input type="checkbox"/> 24602N	idrobox weatherproof cover 2 modules - white
<input type="checkbox"/> 24602	
<input type="checkbox"/> 24602L	
<input type="checkbox"/> 24603N	idrobox weatherproof cover 3 modules - white
<input type="checkbox"/> 24603	
<input type="checkbox"/> 24603L	



24402



24503



24403

Item	IP40 IDROBOX PROTECTING HOUSING
<input type="radio"/> 24401	IP40 composed of base and cover - for 1 module LivingLight
<input type="radio"/> 24402	IP40 composed of base and cover - for 2 module LivingLight
<input type="radio"/> 24403	IP40 composed of base and cover - for 3 module LivingLight

Item	IP55 IDROBOX PROTECTING HOUSING
<input type="radio"/> 24501	IP55 enclosure consists of a base and cover - for 1 modules LivingLight
<input type="radio"/> 24502	IP55 enclosure consists of a base and cover - for 2 modules LivingLight
<input type="radio"/> 24503	IP55 enclosure consists of a base and cover - for 3 modules LivingLight
<input type="radio"/> 24504	IP55 enclosure consists of a base and cover - for 4 modules LivingLight

SPECIAL INSTALLATION

Item	VERTICAL INSTALLATION PLATES
<input type="checkbox"/> LND4811BI <input type="checkbox"/> LND4811TE <input type="checkbox"/> LND4811AR	LL - cover plate for rail 1P white LL - cover plate for rail 1P tech LL - cover plate for rail 1P anthracite
<input type="checkbox"/> LND4812BI <input type="checkbox"/> LND4812TE <input type="checkbox"/> LND4812AR	LL - cover plate for rail 1+1P white LL - cover plate for rail 1+1P tech LL - cover plate for rail 1+1P anthracite

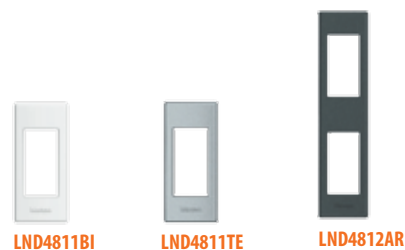

LND4811BI

LND4811TE

LND4812AR

Item	VERTICAL INSTALLATION BOXES
<input type="checkbox"/> 510L	box for masonry wall 1 modules size 27 x 50 x 37 mm.
<input type="checkbox"/> 510LN	LL - box 1 module size 27 x 50 x 37 mm.



510LN*

510L

Item	WALL MOUNTED MULTIBOXES
<input type="checkbox"/> N4714 <input type="checkbox"/> L4714	Light - wall box 14 modules LivInt - wall box 14 modules
<input type="checkbox"/> 150418BA <input type="checkbox"/> 150418GR	Interlink - 18 mod. consumer unit white Interlink - 18 mod. consumer unit black

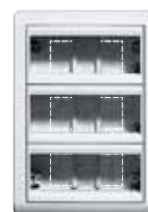

150418BA with supports and cover plates (173x247x65)



L4714 - with support and cover plate (215x215x60)

Item	WALL MOUNTED BOXES
<input type="checkbox"/> 502BI	universal wall-mounting box 2P white
<input type="checkbox"/> 503BI	universal wall-mounting box 3P white
<input type="checkbox"/> 503BP	surface box 2 and 3 modules - 114x79x46 mm.
<input type="checkbox"/> 504BI	universal wall-mounting box 4P white



502BI*

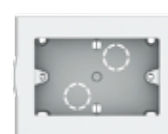

503BI*



503BP

Item	WALL MOUNTED BOXES - BLACK
<input type="checkbox"/> 502LP	wall mounting box 2m black
<input type="checkbox"/> 503LP	wall mounting box 3m black
<input type="checkbox"/> 504LP	wall mounting box 4m black



502LP



503LP



504LP

Item	DESK DEVICE
<input type="checkbox"/> 150433 <input type="checkbox"/> 150434 <input type="checkbox"/> 150432	Interlink - Supporting frame 4P Light Interlink - Supporting frame 4P Light Tech Interlink - Supporting frame 4P Living Int



150433 white

150432 anthracite
150434 Tech

LIGHT COVER PLATES

METALS

Material: zamak



Ice gold -OA



Bronze -BZ

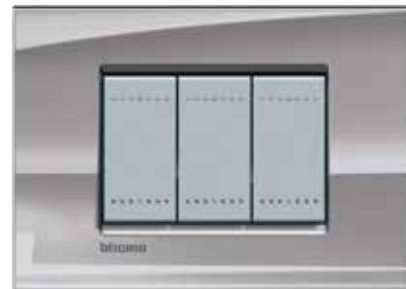

Nickel -NS

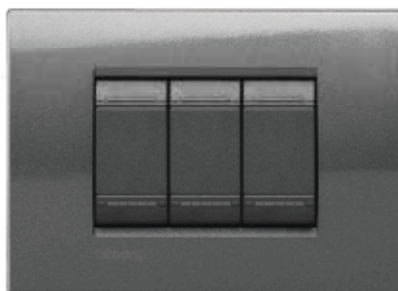

Steel -AC

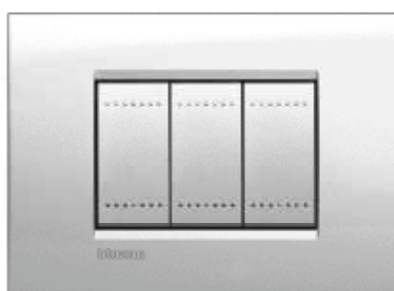

Moonlight -GL

NATURALIA

Material: zamak



Native -NA



Silver -AG



Brushed steel -ACS

SILK

Material: zamak



Park -PK



Square -SQ



Brick -RK















Avenue -AE



Club -CB

SQUARE COVER PLATE CODES

- 2 modules - LNA4802...
- 2 modules centered - LNA4819...
- 3 modules - LNA4803...
- 4 modules - LNA4804...
- 7 modules - LNA4807...
- 3+3 modules - LNA4826...

<p>DEEP Material: polymer plastic</p>	 <p>Green - VD</p>	 <p>Orange - OD</p>	 <p>Blue - AD</p>
<p>KRISTALL Material: polymer plastic</p>	 <p>London fog - KF</p>	 <p>Acquamarine - KA</p>	 <p>Cold grey - KG</p>
<p>NEUTRAL Material: polymer plastic</p>	 <p>Anthracite - AR</p>	 <p>White - BI</p>	 <p>Tech - TE</p>
<p>ESSENCES Material: solid wood</p>	 <p>Cherrywood - LCA</p>	 <p>Bamboo - LBA</p>	 <p>Walnut - LNC</p>

LIGHT COVER PLATES









Table for selecting codes

		MODULES					
		2	2 centered	3	4	7	3 + 3
METALS (zamak)							
	Ice gold	LNA4802OA	LNA4819OA	LNA4803OA	LNA4804OA	LNA4807OA	LNA4826OA
	Bronze	LNA4802BZ	LNA4819BZ	LNA4803BZ	LNA4804BZ	LNA4807BZ	LNA4826BZ
	Nickel	LNA4802NS	LNA4819NS	LNA4803NS	LNA4804NS	LNA4807NS	LNA4826NS
	Steel	LNA4802AC	LNA4819AC	LNA4803AC	LNA4804AC	LNA4807AC	LNA4826AC
	Moolight silver	LNA4802GL	LNA4819GL	LNA4803GL	LNA4804GL	LNA4807GL	LNA4826GL
NATURALIA (zamak)							
	Native	LNA4802NA	LNA4819NA	LNA4803NA	LNA4804NA	LNA4807NA	LNA4826NA
	Silver	LNA4802AG	LNA4819AG	LNA4803AG	LNA4804AG	LNA4807AG	LNA4826AG
	Brushed steel	LNA4802ACS	LNA4819ACS	LNA4803ACS	LNA4804ACS	LNA4807ACS	LNA4826ACS
SILK (zamak)							
	Park	LNA4802PK	LNA4819PK	LNA4803PK	LNA4804PK	LNA4807PK	LNA4826PK
	Square	LNA4802SQ	LNA4819SQ	LNA4803SQ	LNA4804SQ	LNA4807SQ	LNA4826SQ
	Brick	LNA4802RK	LNA4819RK	LNA4803RK	LNA4804RK	LNA4807RK	LNA4826RK
	Avenue	LNA4802AE	LNA4819AE	LNA4803AE	LNA4804AE	LNA4807AE	LNA4826AE
	Club	LNA4802CB	LNA4819CB	LNA4803CB	LNA4804CB	LNA4807CB	LNA4826CB
DEEP (polymer plastic)							
	Green	LNA4802VD	LNA4819VD	LNA4803VD	LNA4804VD	LNA4807VD	LNA4826VD
	Orange	LNA4802OD	LNA4819OD	LNA4803OD	LNA4804OD	LNA4807OD	LNA4826OD
	Blue	LNA4802AD	LNA4819AD	LNA4803AD	LNA4804AD	LNA4807AD	LNA4826AD
KRISTALL (polymer plastic)							
	London fog	LNA4802KF	LNA4819KF	LNA4803KF	LNA4804KF	LNA4807KF	LNA4826KF
	Aquamarine	LNA4802KA	LNA4819KA	LNA4803KA	LNA4804KA	LNA4807KA	LNA4826KA
	Cold grey	LNA4802KG	LNA4819KG	LNA4803KG	LNA4804KG	LNA4807KG	LNA4826KG
NEUTRAL (polymer plastic)							
	Anthracite	LNA4802AR	LNA4819AR	LNA4803AR	LNA4804AR	LNA4807AR	LNA4826AR
	White	LNA4802BI	LNA4819BI	LNA4803BI	LNA4804BI	LNA4807BI	LNA4826BI
	Tech	LNA4802TE	LNA4819TE	LNA4803TE	LNA4804TE	LNA4807TE	LNA4826TE
WOOD							
	Cherrywood	LNA4802LCA	LNA4819LCA	LNA4803LCA	LNA4804LCA	LNA4807LCA	LNA4826LCA
	Bamboo	LNA4802LBA	LNA4819LBA	LNA4803LBA	LNA4804LBA	LNA4807LBA	LNA4826LBA
	Walnut	LNA4802LNC	LNA4819LNC	LNA4803LNC	LNA4804LNC	LNA4807LNC	LNA4826LNC
SUPPORTS							
	Fixing with screws	LN4702	LN4719	LN4703	LN4704	LN4707	LN4726
	Fixing with clips	LN4702G	LN4719G				

KRISTALL

Neutral, transparent, easy to be customised. From total camouflage to vivid graphic impact. KRISTALL is ideal for spaces furnished in a particular style, to camouflage switches and sockets on wall with decorative coverings or finishes. The plate and switch can be personalised with wallpaper inserts or graphic decorations.

ITEMS FOR THE CUSTOMISATION OF THE LIGHT POINT

Item	Customisable transparent key cover for rocker control devices	
○ N4932		1 module
○ N4932/2		2 modules
○ N4932/3		3 modules
	Customisable transparent cover plates	
○ LND4802KR		2 modules
○ LND4819KR		2 modules
○ LND4803KR		3 modules
○ LND4804KR		4 modules
○ LND4807KR		7 modules
○ LND4826KR		3 + 3 modules

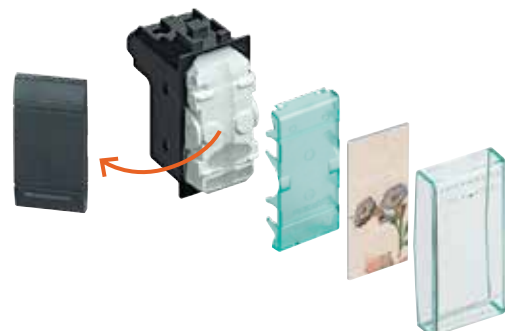

LIVING INTERNATIONAL

Cover plate colours

METALLIC



Light aluminium - AL



Dark steel - AC



Light titanium - TC



Oxidized bronze - BO



Solid black - NR

SHINY

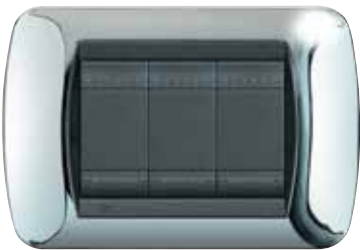

Bright chrome - CR



True gold - OR

SPECIAL



Brushed steel - ACS



Graphite - GF



Black graphite - GFN



Bakelite - BK

LIVINGLIGHT ROUND COVER PLATES CODES

- 2 modules - L4802...
- 3 modules - L4803...
- 4 modules - L4804...
- 7 modules - L4807...
- 3+3 modules - L4826...













* (not available in the modularity 3+3)

NOTE for new plates: White plate with white inner frame, plates Tech, Chrome and Brushed steel with Tech inner frame

LIVING INTERNATIONAL: table for selecting codes















		MODULES				
		2	3	4	7	3 + 3
METALLIC						
	Light aluminium	L4802AL	L4803AL	L4804AL	L48027L	L4826AL
	Dark steel	L4802AC	L4803AC	L4804AC	L48027C	L4826AC
	Light titanium	L4802TC	L4803TC	L4804TC	L4807TC	L4826TC
	Oxidized bronze	L4802BO	L4803BO	L4804BO	L4807BO	L4826BO
	Solid black	L4802NR	L4803NR	L4804NR	L4807NR	L4826NR
SHINY						
	Bright chrome	L4802CR	L4803CR	L4804CR	L4807CR	L4826CR
	True gold	L4802OR	L4803OR	L4804OR	L4807OR	L4826OR
SPECIAL						
	Brushed steel	L4802ACS	L4803ACS	L4804ACS	L4807ACS	L4826ACS
	Graphite	L4802GF	L4803GF	L4804GF	L4807GF	L4826GF
	Black graphite	L4802GFN	L4803GFN	L4804GFN	L4807GFN	L4826GFN
	Bakelite	L4802BK	L4803BK	L4804BK	L4807BK	
TECH						
	Tech	L4802TE	L4803TE	L4804TE	L4807TE	L4826TE
	Chrome	L4802CT	L4803CT	L4804CT	L4807CT	L4826CT
	Brushed steel	L4802AST	L4803AST	L4804AST	L4807AST	L4826AST
POLYMER						
	Dark steel	L4802PA	L4803PA	L4804PA	L4807PA	
	White	L4802PB	L4803PB	L4804PB	L4807PB	
	All White	L4802BI	L4803BI	L4804BI	L4807BI	
SUPPORTS						
	Supports	L4702-L4702G	LN4703	LN4704	LN4707	LN4726

Cover plate colours

MONOCHROME Material: zamak	 <p>Pure white - BN</p>	 <p>Tech - TE</p>	 <p>Anthracite - AR</p>
	 <p>Pewter - PT</p>	 <p>Palladium - PL</p>	 <p>Gold mat - OF</p>
	 <p>Nickel mat - NK</p>	AIR COVER PLATE CODES 2 modules - LNC4802... 3 modules - LNC4803... 4 modules - LNC4804... 7 modules - LNC4807... 3+3 modules - LNC4826...	
SOFT Material: zamak	 <p>Street - ST</p>	 <p>Clay - CY</p>	 <p>Sand - SB</p>
	 <p>Blue moon - BM</p>		



Cover plates: table for selecting codes

		MODULES				
		2	3	4	7	3+3
MONOCHROME (zamak)						
	Pure white	LNC4802BNL	LNC4803BN	LNC4804BNL	LNC4807BN	LNC4826BN
	Tech	LNC4802TEL	LNC4803TE	LNC4804TEL	LNC4807TE	LNC4826TE
	Anthracite	LNC4802ARL	LNC4803AR	LNC4804ARL	LNC4807AR	LNC4826AR
BRUSHED (zamak)						
	Brushed Nickel	LNC4802NIS	LNC4803NIS	LNC4804NIS	LNC4807NIS	LNC4826NIS
	Brushed Titanium	LNC4802TIS	LNC4803TIS	LNC4804TIS	LNC4807TIS	LNC4826TIS
	Brushed Chrome	LNC4802CRS	LNC4803CRS	LNC4804CRS	LNC4807CRS	LNC4826CRS
SHINY (zamak)						
	Pewter	LNC4802PT	LNC4803PT	LNC4804PT	LNC4807PT	LNC4826PT
	Palladium	LNC4802PL	LNC4803PL	LNC4804PL	LNC4807PL	LNC4826PL
	Gold mat	LNC4802OF	LNC4803OF	LNC4804OF	LNC4807OF	LNC4826OF
	Nickel mat	LNC4802NK	LNC4803NK	LNC4804NK	LNC4807NK	LNC4826NK
SOFT (zamak)						
	Street	LNC4802ST	LNC4803ST	LNC4804ST	LNC4807ST	LNC4826ST
	Clay	LNC4802CY	LNC4803CY	LNC4804GCY	LNC4807CY	LNC4826CY
	Sand	LNC4802SB	LNC4803SB	LNC4804SB	LNC4807SB	LNC4826SB
	Blue moon	LNC4802SBM	LNC4803BM	LNC4804BM	LNC4807BM	LNC4826BM
SUPPORTS						
	Supports	LN4702C	LN4703C	LN4704C	LN4707C	LN4726C

INSTALLATION SYSTEM

2 MODULES

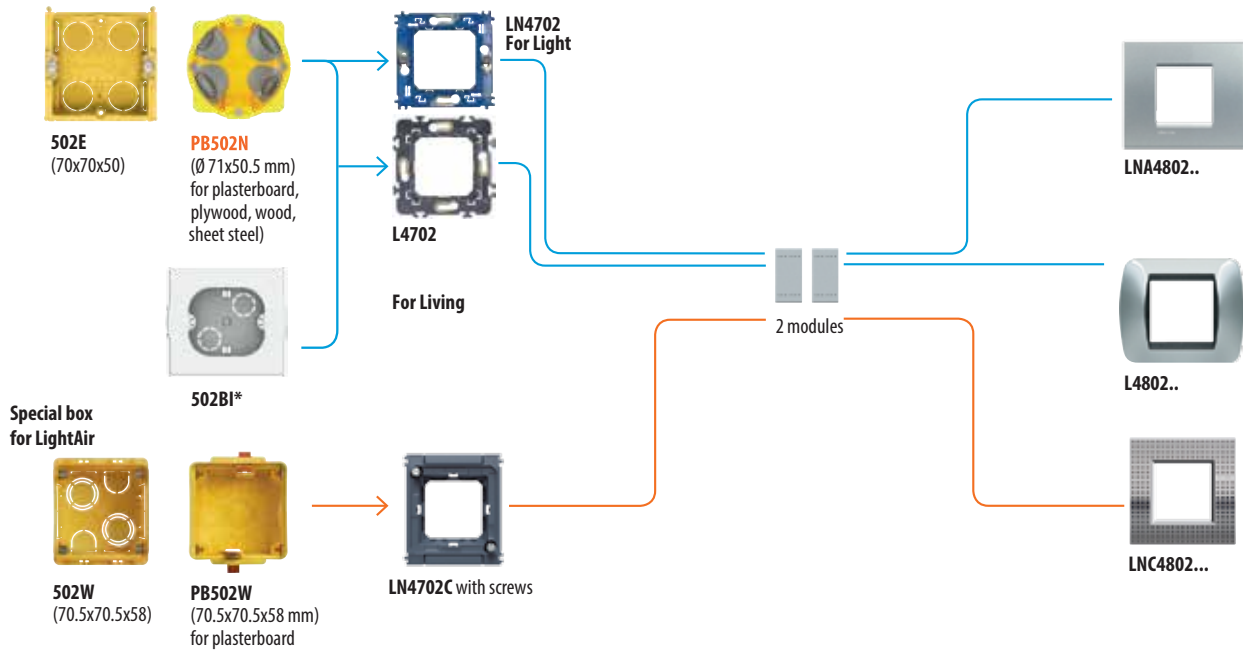

WEATHER PROOF

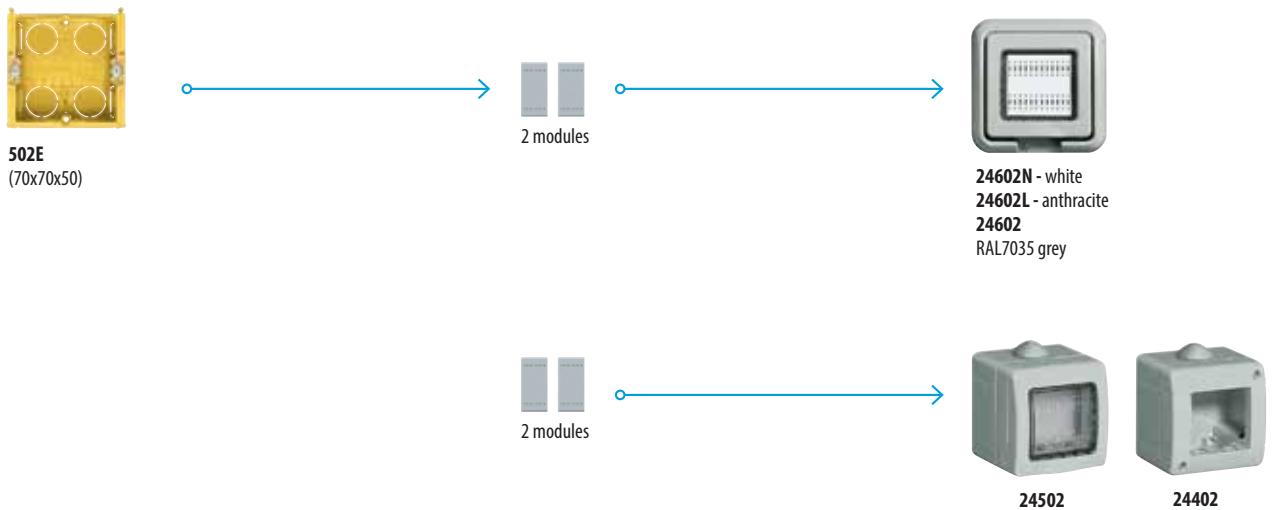

LIVING LIGHT

can be installed using normal flush mounted boxes and 2, 3, 4, 7, and 3+3 module supports. The light point can be completed with square or round cover plates depending on personal taste.

LIGHT AIR

LIVINGLIGHT AIR features reduced protrusion from the wall of the device/cover plate.

- 3, 4, 7 and 3+3 module installation: traditional BTicino flush mounted boxes (503E), or boxes with minimum depth 50 mm.

Suggestions:

- new systems: considering the back position of the mechanisms inside the boxes, for masonry walls the use of box extensions is recommended, for better comfort and wiring
- existing systems: check that the depth of the box is at least 50 mm.

3 MODULES

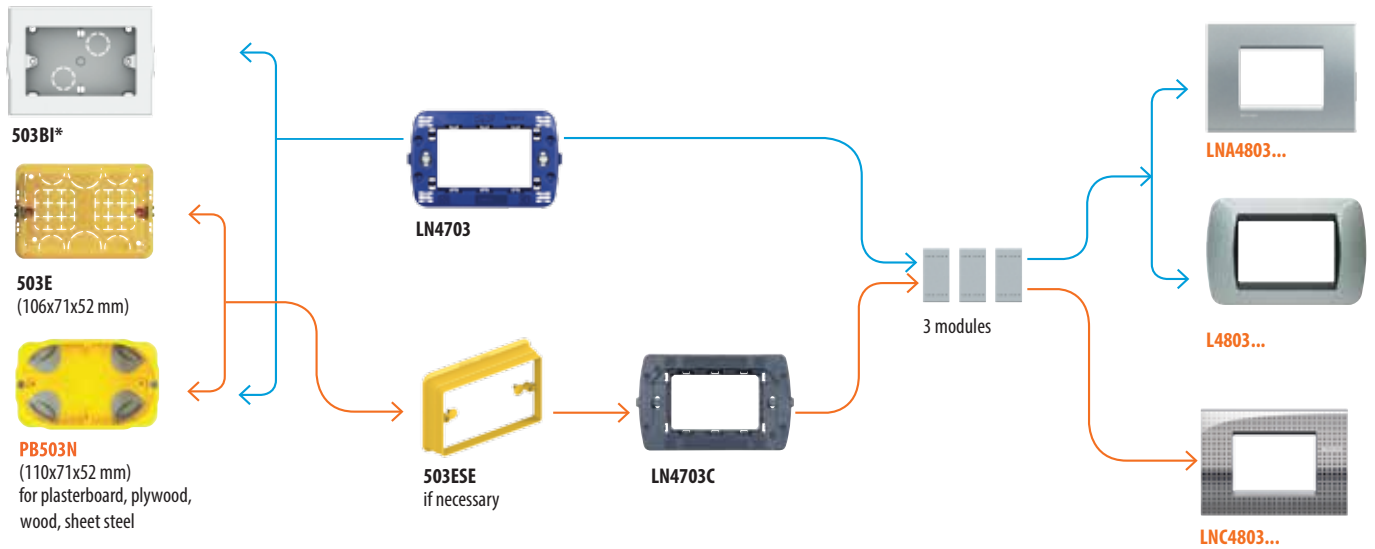

WEATHER PROOF

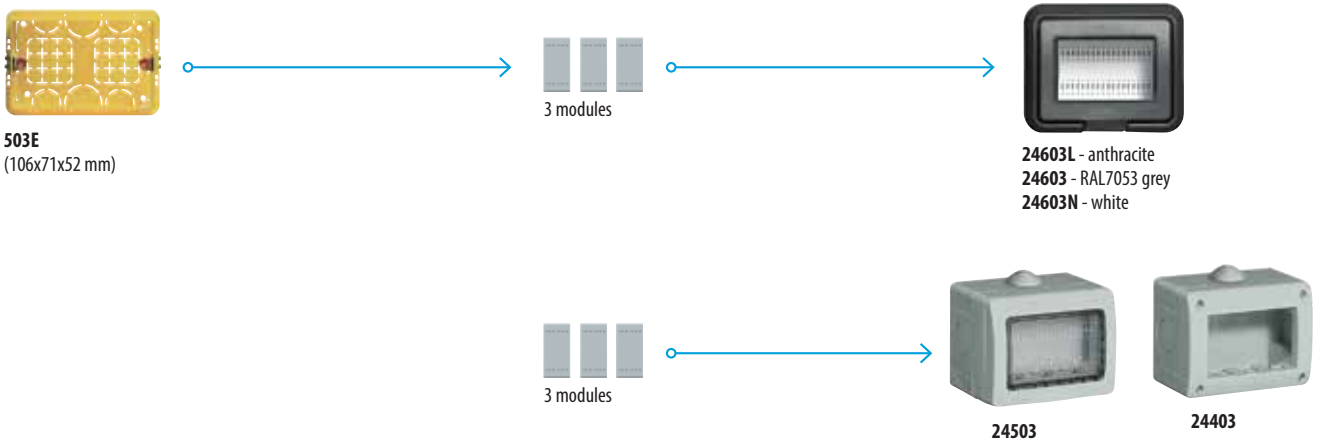

PRODUCTS FOR WHICH THE USE OF THE BOX EXTENSION IS NECESSARY, WHEN INSTALLED WITH LIVINGLIGHT AIR

Box extension	Products to combine	Item
10 A 2 modules	resistive dimmer with built-in two-way switch - 1 module	N4402N NT4402N L4402N
	1 module resistive dimmer	N4406 NT4406 L4406
10 A 1 module axial pushbutton + MH BASIC interface		N4055A NT4055A L4055A
	10 A 2 module axial pushbutton + MH BASIC interface	N4055M2A NT4055M2A L4055M2A
230 Va.c. shaver socket		N4177 NT4177 L4177
	emergency lamp 3 hours - 4 modules	L4384/3
	emergency lamp 3 hours - 6 modules	L4386/3
emergency lamp always on - 3 hours - 6 modules		L4386/3L

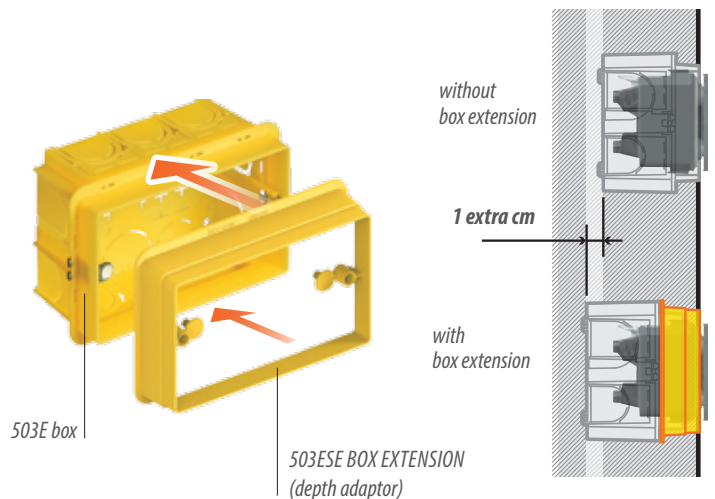

INSTALLATION SYSTEM

4 MODULES

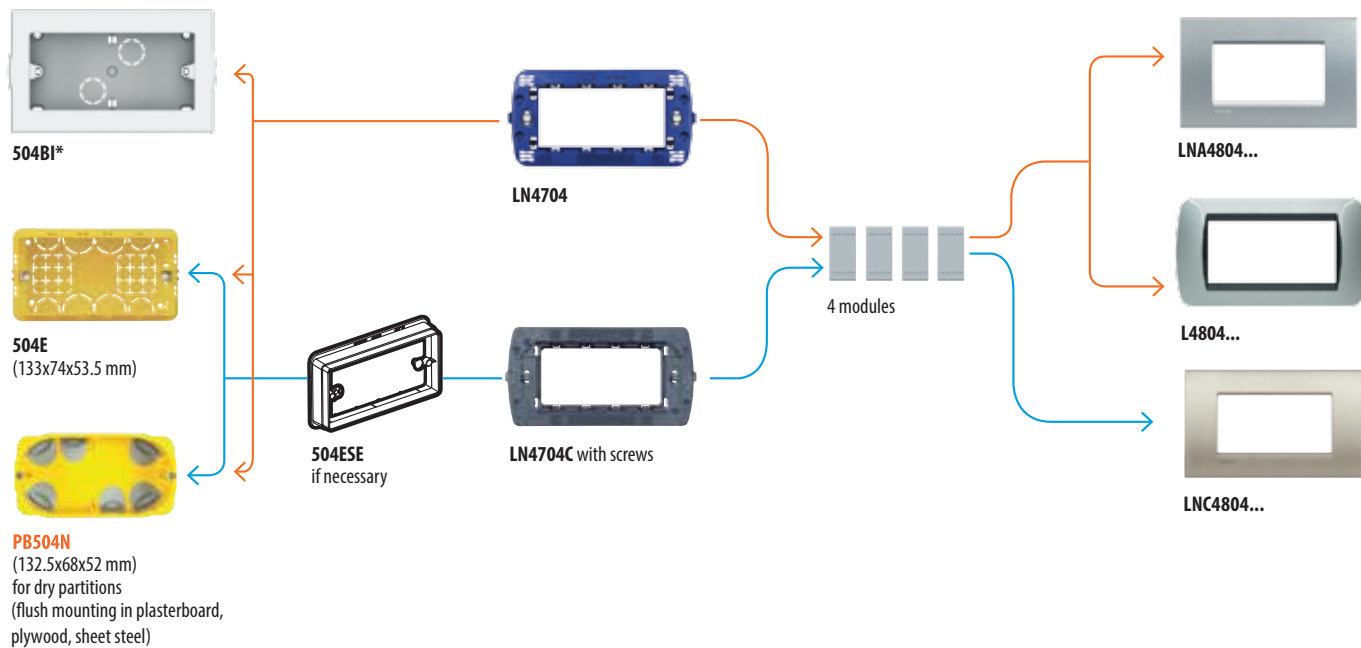

WEATHER PROOF



7 MODULES

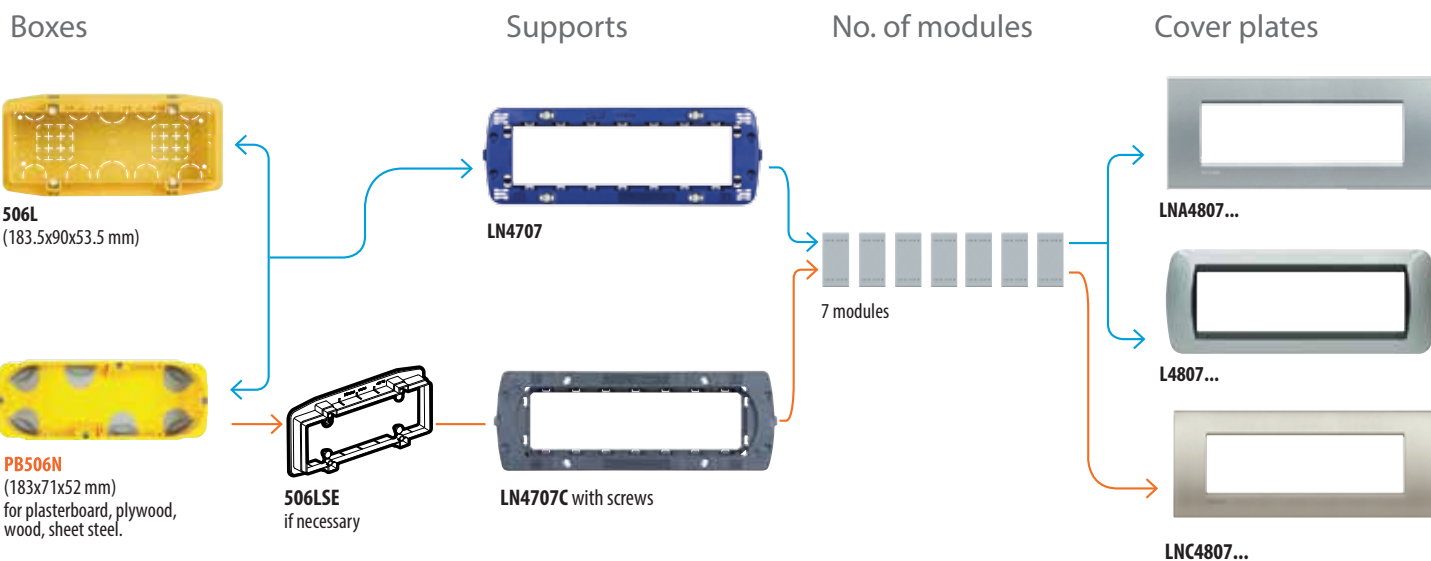

3+3 MODULES

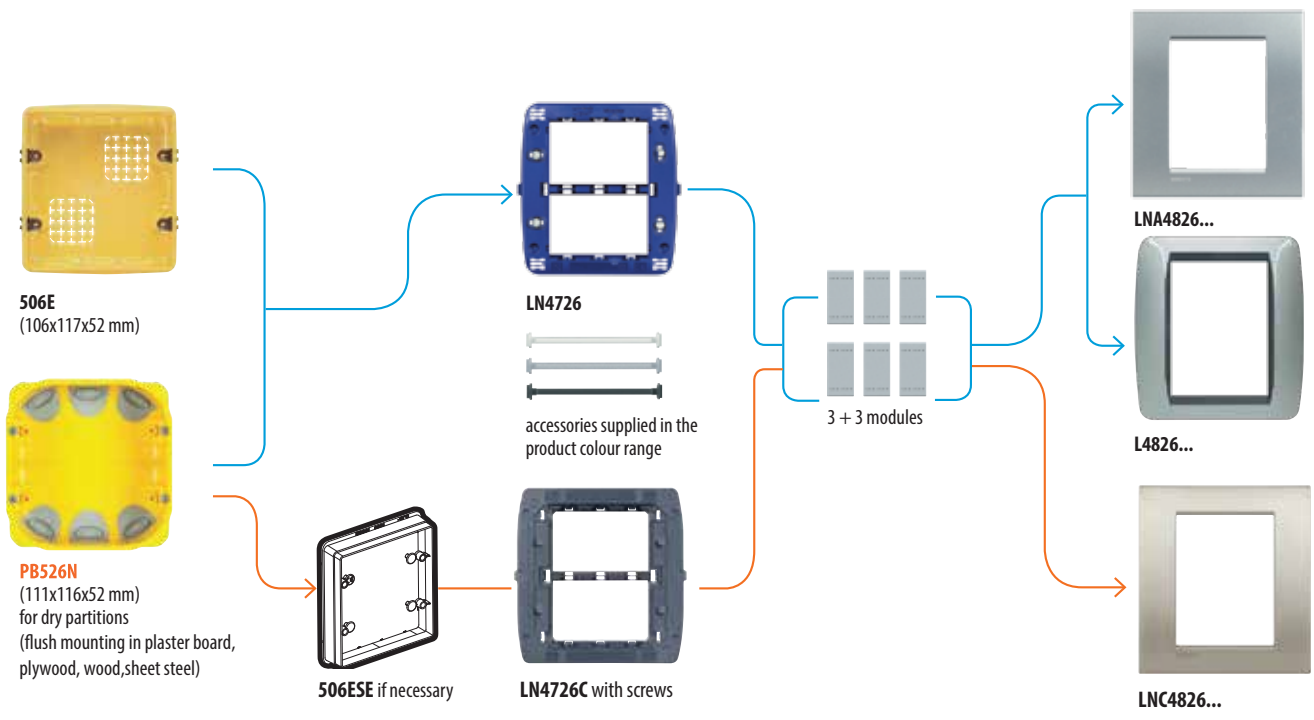

INSTALLATION ON RAILS

Boxes



No. of modules

ON PROFILES

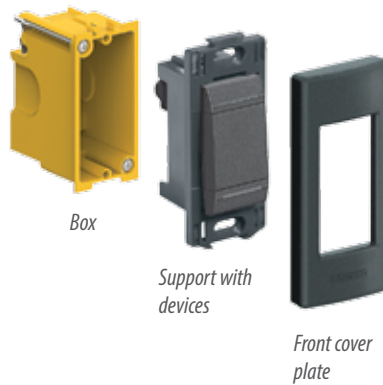

Cover plates with support

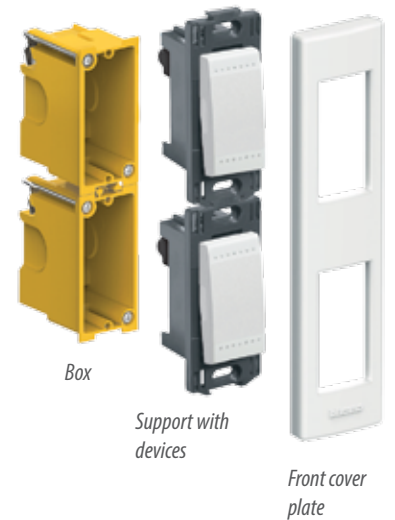

INSTALLATION IN MULTIBOX BOXES

Boxes



16102
(170x234x70)

Frame



16102LT (white)
16102LTG (grey)
16102LTH (Tech)

Supports



16135 (No. 1)

No. of modules

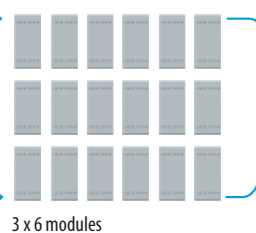

Cover plates

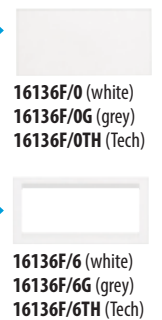

BTicino Concept Store | Bangkok



TRAINING CENTER | BANGKOK

VISIT OUR SHOWROOMS

Monday to Friday (10 a.m. - 5 p.m.)

BTicino (Thailand) Limited

Bangkok | Office
10th F Ploenchit Center,
2 Sukhumvit Road,
Klongtoey, Bangkok 10110
Tel. +66 (0) 2 656 9162 - 7
Fax. +66 (0) 2 656 9197

Bangkok | Concept Store
G Floor Ploenchit Center

Bangkok | Training Center
12th Floor Ploenchit Center

